

scale -1"=3" or 1"=1/2"

# Frame Top & Bottom Bar

Drawn by Gary S. Reuter  
University of Minnesota  
Dept. of Entomology  
12-07-01

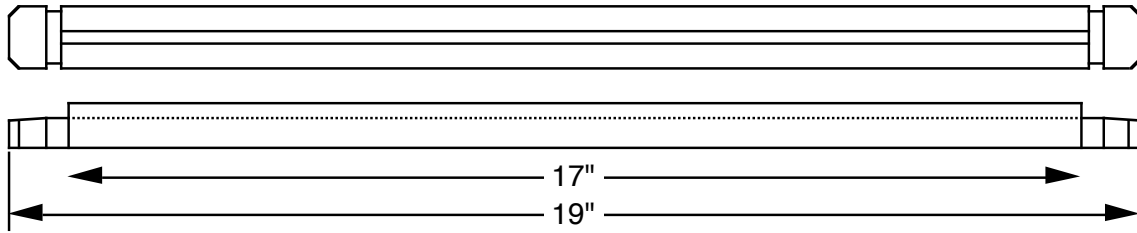

1"=3"



All lumber nominal 3/4" pine unless otherwise specified

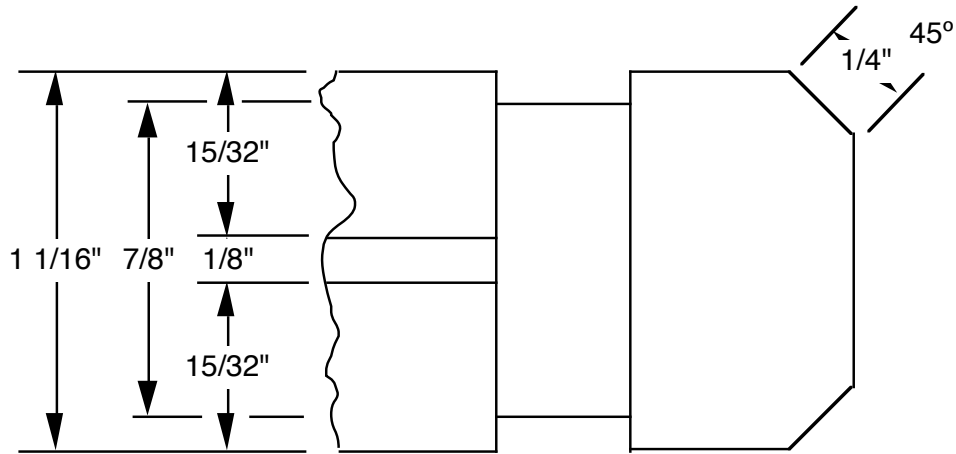

1"=1/2"

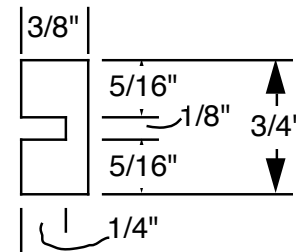
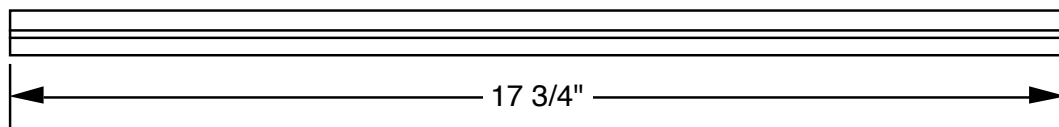
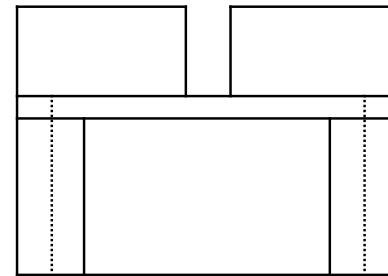
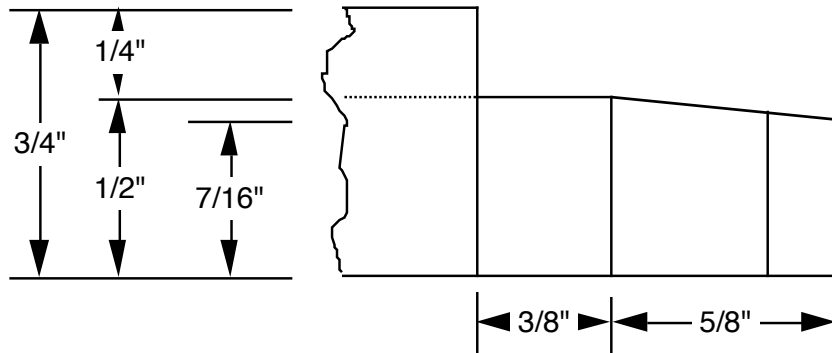

1"=3"

scale -1"=3" or 1"=1/2"

# Frame Top & Bottom Bar

Drawn by Gary S. Reuter  
University of Minnesota  
Dept. of Entomology  
12-07-01

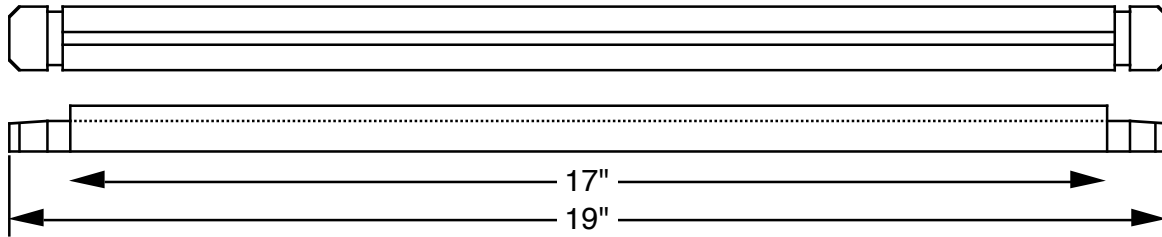

1"=3"

All lumber nominal 3/4" pine unless otherwise specified

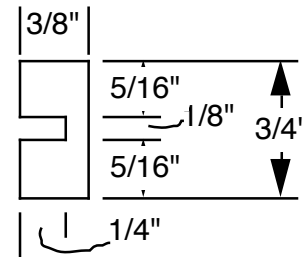
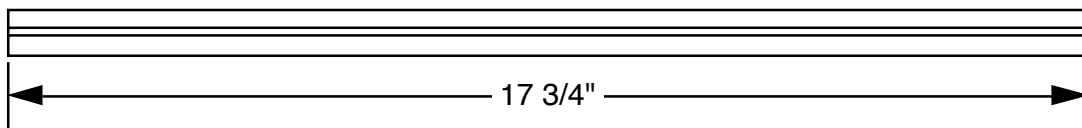
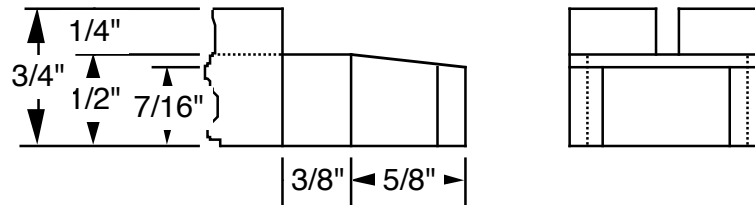
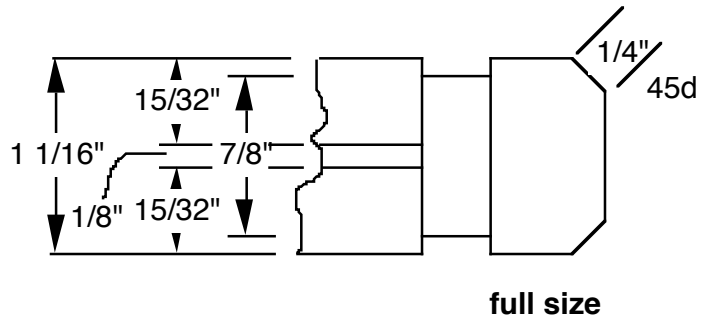

1"=3"

scale -Full size

# Frame end bar

Drawn by Gary S. Reuter  
University of Minnesota  
Dept. of Entomology  
12-07-01

All 3/8" thick - End measurements are the same for each.

